

# Gender Classification Based on Electrocardiogram Signals Using Long Short Term Memory and Bidirectional Long Short Term Memory

Kevin Yudhaprawira Halim, Dodon Turianto Nugrahadi, Mohammad Reza Faisal, Rudy Herteno, Irwan Budiman

Computer Science Department, Lambung Mangkurat University, Jalan A.Yani Km 36, Banjarbaru 70714, Indonesia

## ARTICLE INFO

### Article history:

Received June 05, 2023

Revised July 15, 2023

Published July 18, 2023

### Keywords:

Gender Classifications;  
Electrocardiogram Signal;  
BiLSTM;  
LSTM;  
Biometric

## ABSTRACT

Gender classification by computer is essential for applications in many domains, such as human-computer interaction or biometric system applications. Generally, gender classification by computer can be done by using a face photo, fingerprint, or voice. However, researchers have demonstrated the potential of the electrocardiogram (ECG) as a biometric recognition and gender classification. In facilitating the process of gender classification based on ECG signals, a method is needed, namely Long Short-Term Memory (LSTM) and Bidirectional Long Short-Term Memory (Bi-LSTM). Researchers use these two methods because of the ability of these two methods to deal with sequential problems such as ECG signals. The inputs used in both methods generally use one-dimensional data with a generally large number of signal features. The dataset used in this study has a total of 10,000 features. This research was conducted on changing the input shape to determine its effect on classification performance in the LSTM and Bi-LSTM methods. Each method will be tested with input with 11 different shapes. The best accuracy results obtained are 79.03% with an input shape size of  $100 \times 100$  in the LSTM method. Moreover, the best accuracy in the Bi-LSTM method with input shapes of  $250 \times 40$  is 74.19%. The main contribution of this study is to share the impact of various input shape sizes to enhance the performance of gender classification based on ECG signals using LSTM and Bi-LSTM methods. Additionally, this study contributes to selecting an appropriate method between LSTM and Bi-LSTM on ECG signals for gender classification.

This work is licensed under a [Creative Commons Attribution-Share Alike 4.0](https://creativecommons.org/licenses/by-sa/4.0/)



## Corresponding Author:

Mohammad Reza Faisal, Universitas Lambung Mangkurat, Jalan Ahmad Yani, Banjarbaru 70712, Indonesia.

Email: [reza.faisal@ulm.ac.id](mailto:reza.faisal@ulm.ac.id)

## 1. INTRODUCTION

Gender is identified as one of the fundamental attributes in helping humans. This attribute is used in various fields of facial recognition, soft biometrics, and Human and Computer Interaction (HCI), such as security systems, video surveillance systems, online purchasing systems, justice systems, transportation, drugs, and collection of demographic information [1]-[2]. In other respects, gender is an essential part of the forensic field. Gender grouping aims to assist victims of any criminal or civil cases, as well as solution through the assistance of missing persons [3]. Gender classification is a way to classify individuals referring to the process of assigning male and female labels to biometric samples [4], [5]. Gender grouping can be done using facial assistance, using assistance from a person's way of walking, carried out using dental X-rays, using text data assistance, and can be carried out using electrocardiogram signals [1]-[10].

Generally, gender classification by computer can be done by using a face photo, fingerprint, or voice. However, researchers have demonstrated the potential of the electrocardiogram (ECG) as a biometric

recognition and gender classification. The ECG is a diagnostic tool that displays the best representation of the electrophysiological pattern of depolarization and repolarization of the heart muscle in each heartbeat and has been widely used in the prognosis and diagnosis of various diseases and disorders [11]-[12]. The ECG is a graph of voltage versus time of the heart's electrical activity recorded by electrodes and placed on the skin [13]. The electrocardiogram (ECG) signal reflects changes in heart potential that is unique and easy to measure so that it can be used as a specific measurement tool for human identification [14]-[17]. The ECG signal depicts a graph of cardiac activity and is believed to have morphological or structural differences in each individual and is stable for long periods. ECG is a recording of heartbeats which is one of the most critical tools in diagnosing heart disease [18]. However, ECG signals are also unique between individuals because the signals generated are related to the shape or condition of the human heart, age, and gender [19], [20], [21].

In facilitating the process of gender classification based on ECG signals, a machine-learning technique is needed. Machine learning can be defined as the process of extracting hidden data from large data sets. Machine learning methods are widely used in various fields [22]. By using machine learning methods, predicting, classifying, filtering, and grouping data can be carried out [23]. Machine learning methods that can be used in classification are Long Short-Term Memory (LSTM) and Bidirectional Long Short-Term Memory (Bi-LSTM) [24]-[25]. LSTM is an evolution of the RNN architecture with the addition of memory cells which are used to store information for a long time, as well as to overcome the vanishing gradient problem found in [26], [27]. LSTM shows great efficiency in data classification in many applications [28]. While Bi-LSTM is a method that has a forward layer and a backward layer, with this layer Bi-LSTM can store past and future information effectively and has a greater effect on classification accuracy [29], [30].

Previous related research discussed the classification of heartbeats using electrocardiogram signals with the one-layer LSTM model Kim [31]. The results showed that the accuracy obtained was 95% with an epoch of 200. Subsequent related research discusses the classification of answers using the Bi-LSTM with three questions: greetings, daily conversations, and meetings. The results of this study indicate that the Bi-LSTM accuracy value is 0.909 with a validation loss value of 0.316 [32]. This research shows that Bi-LSTM can be used as an alternative method in classifying.

In previous studies using the LSTM and Bi-LSTM methods which have been carried out using one-dimensional data with a large number of features. In general, the performance of humans in thinking, working machines, or machine learning algorithms in processing data is strongly influenced by the form of the input data. Based on this, we hypothesize that changing the form of data input on LSTM and Bi-LSTM can also impact gender classification performance on ECG signal data. This research proposes a way to change the shape of the input data simply by folding it in half continuously so that two-dimensional data with various sizes are formed. This study focuses on calculating classification performance in the LSTM and Bi-LSTM methods which are inputted with data of various shapes. Classification performance results will be analyzed to determine the effect of input data shape on gender classification performance based on ECG signal data.

The main contribution of this research is to find the impact of various input shape sizes to enhance the performance of gender classification based on ECG signals using LSTM and Bi-LSTM methods. In this study, we find that specific input data shapes can improve the performance of the classification method. This study contributes to selecting an appropriate method between LSTM and Bi-LSTM on ECG signals for gender classification.

## 2. METHODS

### 2.1. Dataset

The methods used in this research are data collection, normalization, data split, model building, classification using LSTM and BiLSTM, results, and evaluation. The detailed research flowchart can be found in Fig. 1.

In this study, the dataset used was electrocardiogram (ECG) signal data from the website <https://physionet.org/content/ecgiddb/1.0.0/>. Each sample consists of three files, namely the binary files named MIT Signal files (.dat) consisting of digitized signal samples., and the contents of the associated signal files are described by MIT Header files (.hea), which are concise text files, and the annotation file for that record (.atr). Two signal datasets are obtained by reading the three files, namely raw and filtered signals. After extracting all the files, two datasets are obtained with details that can be seen in Table 1. Raw ECG data can be seen in Table 2, and filtered ECG data can be seen in Table 3.

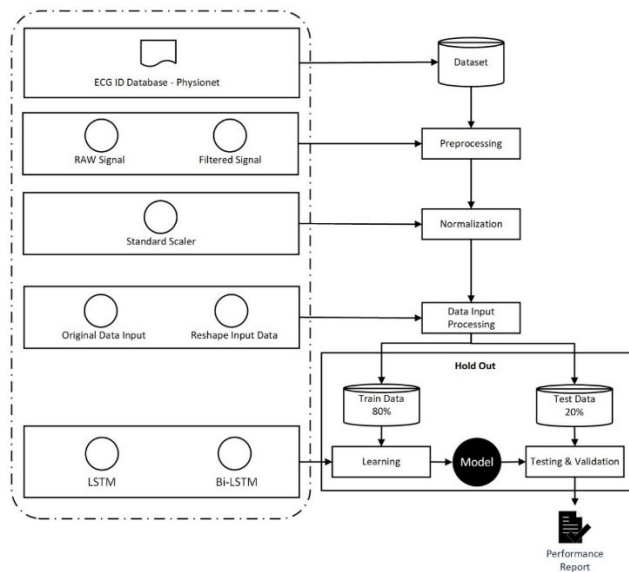

Fig. 1. Research flowchart.

Table 1. Datasets

Dataset	# Sample	# Feature	Target Label
Raw Signal	154	10.000	male
	156	10.000	female
Filtered Signal	154	10.000	male
	156	10.000	female

Table 2. Raw ECG Data

X0	X1	X2	X3	...	X9997	X9998	X9999	Target Label
-0.085	-0.080	-0.070	-0.075	...	-0.065	-0.080	-0.08	male
0.105	0.135	0.115	0.065	...	-0.175	-0.165	-0.05	male
0.125	0.06	0.07	0.085	...	-0.025	0	0.05	male
0.045	0.105	0.08	0.155	...	0.04	0.02	-0.04	male
-0.185	-0.24	-0.195	-0.2	...	-0.04	-0.07	-0.06	male
...	...	...	...	...	...	...	...	...
-0.82	-0.335	-0.18	-0.145	...	0.06	-0.395	-0.785	male
-0.46	-0.25	-0.145	-0.04	...	0.6	-0.01	-0.615	female
0.945	0.44	-0.26	-0.92	...	-0.105	0.005	-0.03	female
-0.04	-0.145	0.1	0.195	...	0.32	0.22	0.27	female
-0.08	-0.16	-0.04	-0.08	...	0.18	0.245	0.165	female

Table 3. Filtered ECG Data

X0	X1	X2	X3	...	X9997	X9998	X9999	Target Label
-0.115	-0.115	-0.12	-0.12	...	-0.035	-0.035	-0.035	male
0.105	0.06	0.02	-0.02	...	-0.015	-0.02	-0.03	male
-0.035	-0.045	-0.045	-0.045	...	0.01	-0.005	-0.01	male
-0.22	-0.17	-0.135	-0.105	...	-0.065	-0.07	-0.075	male
-0.085	-0.07	-0.05	-0.035	...	0.02	0.02	0.025	male
...	...	...	...	...	...	...	...	...
-0.69	-0.335	-0.09	0.115	...	-0.035	-0.17	-0.355	male
-0.245	0	0.13	0.22	...	-0.07	-0.17	-0.345	female
0.88	0.335	-0.01	-0.285	...	-0.035	-0.015	0.02	female
-0.12	-0.09	-0.065	-0.04	...	0.19	0.195	0.195	female
0.005	0.015	0.01	0.01	...	0.065	0.08	0.09	female

2.2. Normalization

At this stage, data preprocessing is carried out. Preprocessing is a method for obtaining complete, consistent, and interpretable data. Preprocessing affects the level of accuracy produced in the classification

process. Preprocessing is done through normalization [33], [34]. Normalization is the process by which the data attributes that are in the model are categorized to increase the association of entity types and help reduce the possibility of inconsistent data. The normalization used uses the Standard Scaler which is a normalization based on the average value and standard deviation of the data [35]. The data contained in Table 2 and Table 3 were normalized using the Standard Scaler, with the results shown in Table 4 and Table 5.

**Table 4.** Raw Data Normalization Results

X0	X1	X2	X3	...	X9997	X9998	X9999	Target Label
-0.076	-0.078	-0.058	-0.069	...	0.048	0.046	0.046	male
0.415	0.489	0.424	0.293	...	0.035	0.036	0.049	male
0.467	0.291	0.307	0.345	...	0.052	0.055	0.061	male
0.265	0.410	0.333	0.527	...	0.060	0.057	0.050	male
-0.335	-0.500	-0.384	-0.393	...	0.051	0.047	0.048	male
...	...	...	...	...	...	...	...	...
-1.979	-0.751	-0.345	-0.250	...	0.062	0.010	-0.034	male
-1.047	-0.527	-0.254	0.021	...	0.124	0.054	-0.014	female
2.591	1.294	-0.554	-2.261	...	0.043	0.055	0.051	female
0.040	-0.249	0.385	0.631	...	0.092	0.080	0.086	female
-0.063	-0.289	0.020	-0.082	...	0.076	0.083	0.074	female

**Table 5.** Filtered Data Normalization Results

X0	X1	X2	X3	...	X9997	X9998	X9999	Target Label
-0.772	-1.334	-1.900	-1.798	...	-0.039	-0.037	-0.038	male
1.104	1.154	0.718	-0.068	...	-0.006	-0.013	-0.030	male
-0.090	-0.338	-0.497	-0.500	...	0.034	0.010	0.002	male
-1.668	-2.116	-2.181	-1.538	...	-0.088	-0.095	-0.105	male
-0.516	-0.694	-0.591	-0.327	...	0.051	0.051	0.060	male
...	...	...	...	...	...	...	...	...
-5.678	-4.462	-1.339	2.267	...	-0.039	-0.258	-0.567	male
-1.882	0.301	2.775	4.083	...	-0.096	-0.258	-0.551	female
7.716	5.065	0.156	-4.652	...	-0.039	-0.005	0.052	female
-0.815	-0.978	-0.871	-0.414	...	0.330	0.337	0.341	female
0.251	0.514	0.531	0.450	...	0.124	0.149	0.167	female

### 2.3. Data Input Processing

In this stage, two processes are carried out. The first process is "original data input", this process does not perform any processing and only forwards the data obtained in the previous step. The second process is the process we propose. In this process, the shape of the input data is changed by folding it. For example, the original data has 10,000 features. After folding, it will be 5000×2, the data will be processed in the next stage. Then the original data will be folded back into 2500×4 and resumed for processing at a later stage. In this process, input data will be obtained with ten shapes, as shown Table 6.

**Table 6.** Data input processing results.

Dataset code	Dimension	Description
data_1	10.000 × 1	Original data input shape
data_2	5000 × 2	
data_4	2500 × 4	
data_5	2000 × 5	
data_8	1250 × 8	
data_10	1000 × 10	Proposed data input shape
data_20	500 × 20	
data_25	400 × 25	
data_40	250 × 40	
data_50	200 × 50	
data_100	100 × 100	

## 2.4. Hold Out

After data input processing, the next step is dividing the dataset into test and training data. The dataset is divided into 80% train data and 20% test data. The method of dividing the data in this study is known as hold out [36].

## 2.5. Learning

At this stage, the learning process is carried out on LSTM and Bi-LSTM using training data, and gender classification is carried out for each model. Based on the dataset that has been obtained in Table 6, 22 models for LSTM will be produced using raw and filtered signals. In the research using the Bi-LSTM method, 22 models were produced from raw and filtered signals. So that produced 44 models.

The LSTM layer is a type of RNN which has long dependency learning capability and is based on utilizing feedback connections. The LSTM layer is a combination of memory cells and gates, namely input, output, forget and candidate gates. The input and output gates have the sigmoid activation function, and the candidate gates have the Tanh function. LSTM has two outputs:ory cell and hidden states [37], [28]. LSTM architecture can be seen in Fig. 2.

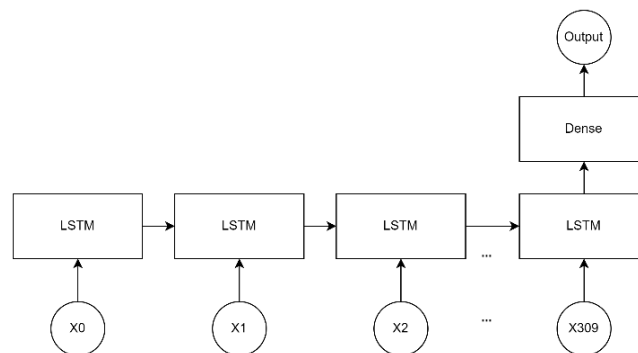

Fig. 2. LSTM Architecture.

Bidirectional LSTM has a forward layer and a backward LSTM layer. Bi-LSTM effectively considers previous and future information to deal with contextual information [29]. The basis of the stacked Bi-LSTM is the time sequence  $T$ , the input sequence  $\{x_1, x_2, \dots, x_T\}$  enters the hidden layer in the forward direction  $\{a_1, a_2, \dots, a_T\}$  to get complete information of all previous time steps and the hidden layer in the reverse direction  $\{c_1, c_2, \dots, c_T\}$  to get complete information of all future time steps. After that the upper hidden layer takes the output of the lower hidden layers at each time step as input to extract further features. In particular, the upper layers of the forward hidden layer are  $\{b_1, b_2, \dots, b_T\}$  and the upper layers of the forward hidden layers are  $\{d_1, d_2, \dots, d_T\}$ . Finally, the output layer integrates the two upper layers hidden vectors together as the output [38]. Bi-LSTM architecture can be seen in Fig. 3.

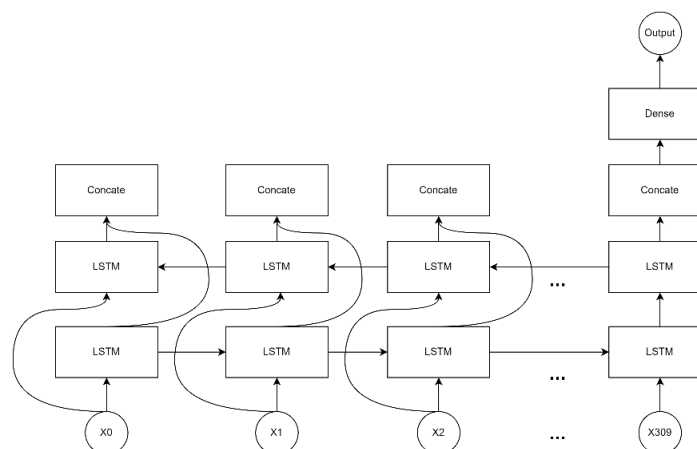

Fig. 3. Bi-LSTM Architecture.

**2.6. Testing and Validation**

At this stage, 44 classification models generated from the learning process will predict the target label from the testing data. The classification results from the performance of the LSTM and Bi-LSTM models are obtained in the form of gender classification.

**2.7. Performance Report**

The performance report stage is an evaluation stage that is carried out after the classification process and is carried out using a confusion matrix. The Confusion Matrix contains information about the actual classifications and predictions made by the classification system. The confusion matrix will compare the classification results performed by the system with the actual classification [39]. The confusion matrix is represented by a table which states the amount of testing data that is classified correctly and the amount of testing data that is classified incorrectly [40]. The table of the confusion matrix can be seen in Table 7.

**Table 7.** Confusion Matrix

Classification		Observed Class	
		Class = Yes	Class = No
Predicted Class	Class = Yes	True positive (TP)	False positive (FP)
	Class = No	False negative (FN)	True negative (TN)

The confusion matrix generated from each model will be used to calculate accuracy. Accuracy was chosen to calculate model performance because this research is a classification case with balanced data so that the accuracy is sufficient to provide information about the performance of the classification model.

**3. RESULTS AND DISCUSSION**

**3.1 Results**

The implementation of LSTM and Bi-LSTM in this study uses the Python programming language with the Keras library. The high-level API of the TensorFlow platform is called Keras. It offers a user-friendly, highly effective interface for resolving machine learning (ML) issues, with a particular emphasis on contemporary deep learning. The entire machine learning pipeline, from data processing to hyperparameter tuning to deployment, is covered by Keras. It was created to facilitate fast experimentation.

**A. LSTM**

The LSTM architecture used in this study can be seen in Fig. 4. The explanation of the architecture can be seen in Table 8.

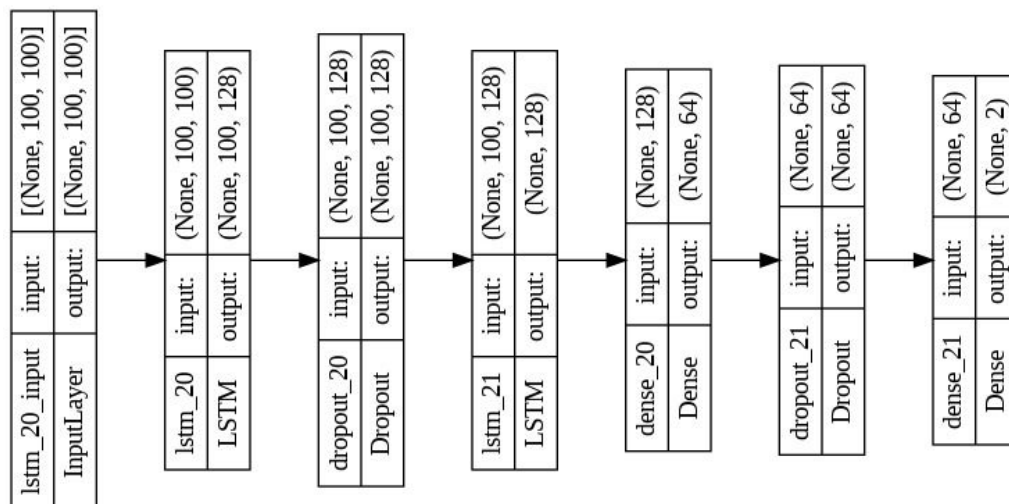

**Fig. 4.** LSTM Architecture.

**Table 8.** LSTM Architecture’s layers, shapes, and params.

Layer (type)	Output Shape	Param #
lstm_20 (LSTM)	(None, 100, 128)	117248
dropout_20 (Dropout)	(None, 100, 128)	0
lstm_21 (LSTM)	(None, 128)	131584
dense_20 (Dense)	(None, 64)	8256
dropout_21 (Dropout)	(None, 64)	0
dense_21 (Dense)	(None, 2)	130

Total params: 257,218  
Trainable params: 257,218  
Non-trainable params: 0

The LSTM architecture in Fig. 4 is one example of the classification model used in this study. The number of layers, layer types, and parameters used are the same. The difference is only in the input layer because it adjusts the input dimensions, as seen in Table 6.

The results of implementing the LSTM method for processing raw signal datasets can be seen in Fig. 5, which shows the highest accuracy obtained by using the code data\_50 dataset, which uses input data with dimensions of 200×50. The performance model using the code data\_50 dataset is 57.28%.

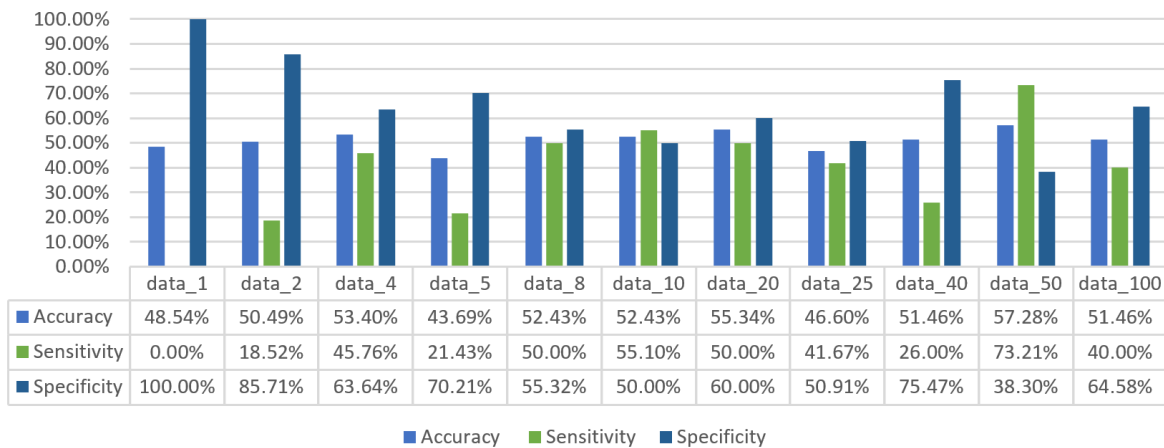

**Fig. 5.** LSTM performance on raw signal dataset.

The results of implementing the LSTM method for processing filtered signal datasets can be seen in Fig. 6, which shows the highest accuracy is obtained using the code data\_50 dataset with dimensions of 200×50. The performance model using the code data\_50 dataset is 79.17%.

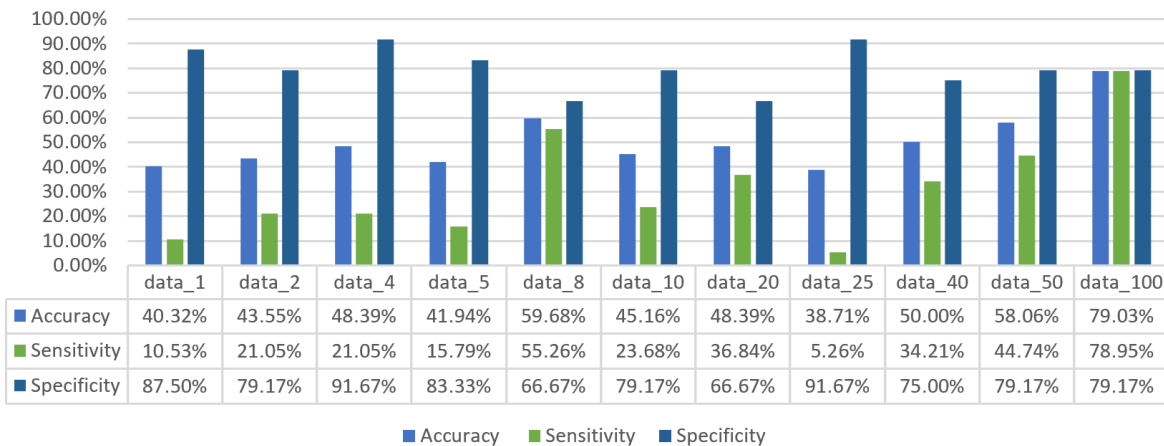

**Fig. 6.** LSTM performance on a filtered signal dataset.



**B. Bi-LSTM**

The Bi-LSTM architecture used in this study can be seen in Fig. 7. The explanation of the architecture can be seen in Table 9.

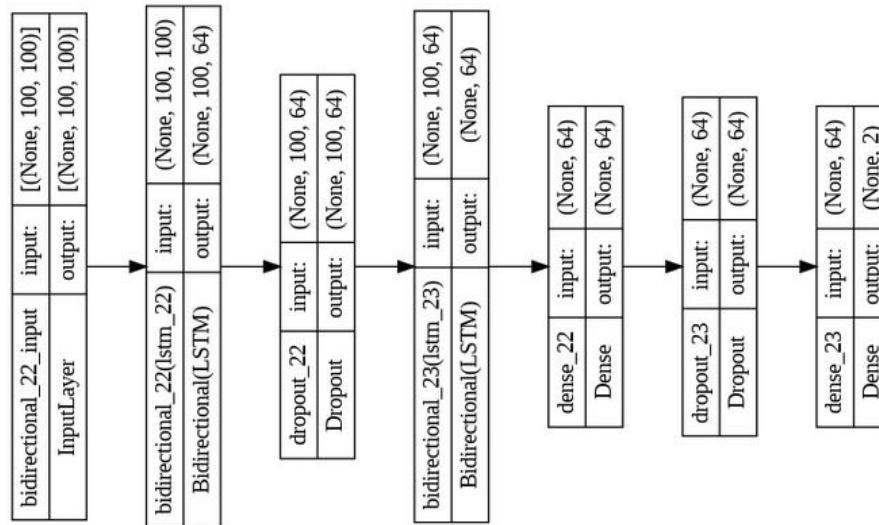

Fig. 7. Bi-LSTM Architecture.

Table 9. Bi-LSTM Architecture’s layers, shapes, and params.

Layer (type)	Output Shape	Param #
bidirectional_22 (Bidirectional)	(None, 100, 64)	34048
dropout_22 (Dropout)	(None, 100, 64)	0
bidirectional_23 (Bidirectional)	(None, 64)	24832
dense_22 (Dense)	(None, 64)	4160
dropout_23 (Dropout)	(None, 64)	0
dense_23 (Dense)	(None, 2)	130

Total params: 63,170  
Trainable params: 63,170  
Non-trainable params: 0

The results of implementing the Bi-LSTM method for processing raw signal datasets can be seen in Fig. 8, which shows that the highest accuracy is obtained using the code data\_100 dataset, which uses input data with dimensions of 200×50. The performance model using the code data\_50 dataset is 0.66129 or 79.0323%.

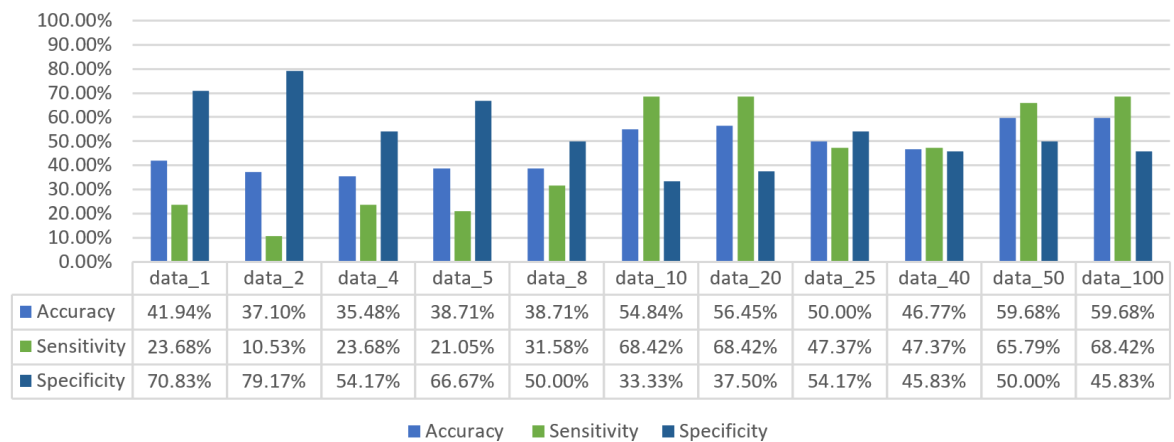

Fig. 8. Bi-LSTM performance on the raw signal dataset.



The results of implementing the LSTM method for processing filtered signal datasets can be seen in Fig. 9, which shows the highest accuracy is obtained using the code data\_40 dataset with dimensions of 250×40. The performance model using the code data\_40 dataset is 74.19%.

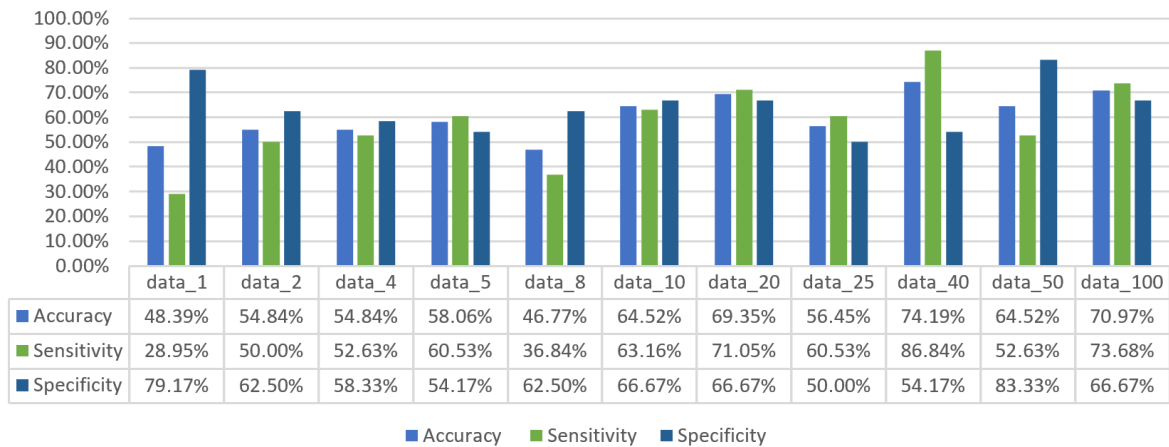

Fig. 9. Bi-LSTM performance on filtered signal dataset.

### 3.2 Discussion

From the results above, the best results can be compared based on the method, signal type, and shape data used. The comparison results can be seen in Fig. 10. Based on this comparison, the best model performance is obtained using the LSTM method on a filtered signal dataset with shape data\_100 with dimensions of 100×100. These results show that the classification performance of models built using the LSTM method produces lower performance than Bi-LSTM when processing Raw signal datasets. However, the performance of the LSTM model is capable of producing higher performance when processing filtered signal datasets.

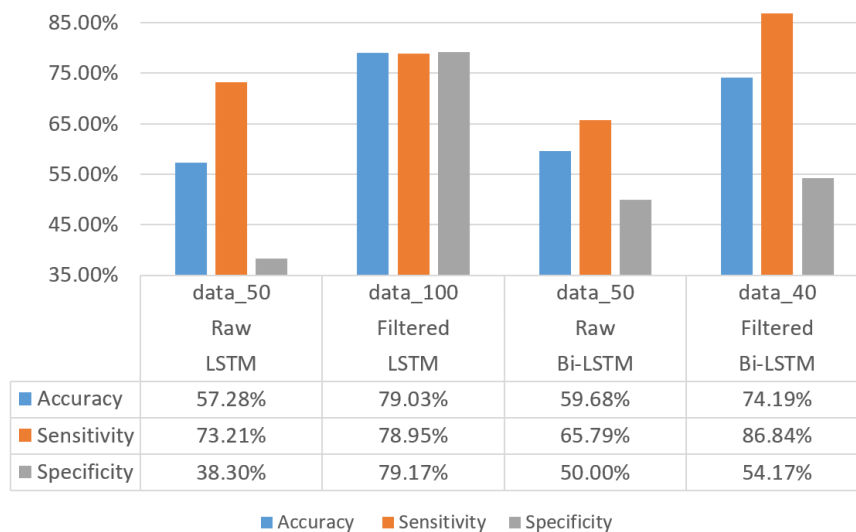
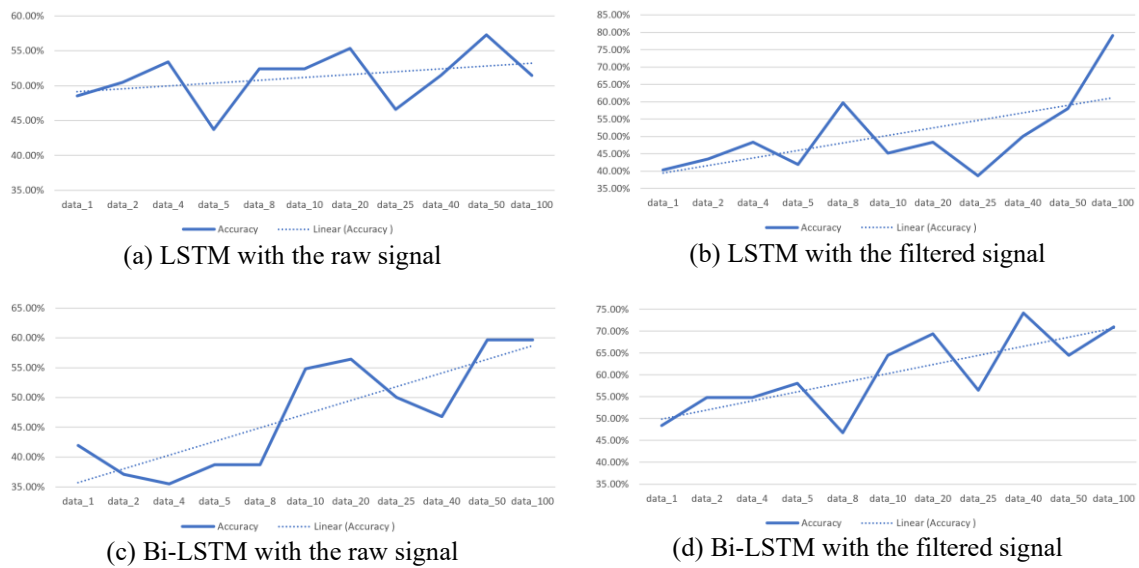

Fig. 10. Comparison of the model's best performance.

This study focuses on the influence of the input shape dimensions on improving the performance of the LSTM and Bi-LSTM classifications. The results of this study indicate that the dimensions of the input shape formed by more and more folds relatively improve the classification performance. Evidence of this statement can be seen in Fig. 11.

In Fig. 11 shows there are several input data with certain shapes that are less processed compared to the previous shape, but the trendline on the graph shows the trend of increasing classification performance. This shows that the classification algorithm can work well if given input data with more folds.



**Fig. 11.** Effect data input shape in classification performance.

The results of this study also show that changing the shape of the input data by folding can improve classification performance when compared to using the original shape. Fig. 12 shows the comparison between the previous and our proposed methods. The previous method is research conducted using the LSTM and Bi-LSTM methods, which use input data with the original shape. Input data with original shape is ECG signal data with one dimension.

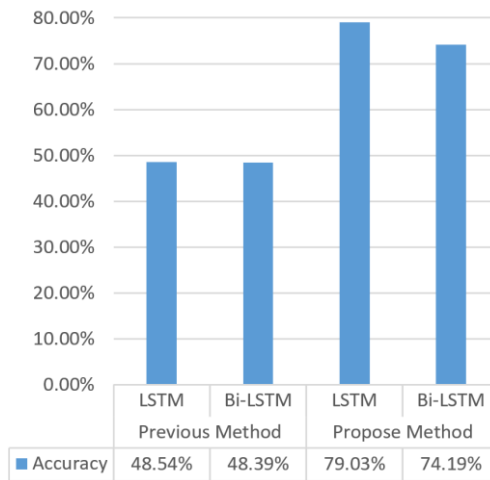

**Fig. 12.** Comparison of previous and out propose method.

**4. CONCLUSION**

This study applies the Long Short-Term Memory and Bidirectional Long-Term Memory methods to classify gender using electrocardiogram (ECG) signals. The data used is in the form of filtered ECG data and raw EKG data. In the implementation using LSTM and Bi-LSTM, 11 effective input shapes are used to increase accuracy. The LSTM shows the highest accuracy results on filtered data with input shapes 100 x100, equal to 79.03%. Whereas the Bi-LSTM shows the highest accuracy results on filtered data with input shapes 250 x 40 which is equal to 74.19%. Therefore, based on research results, LSTM is the best method for classifying gender based on ECG signals because it has the highest accuracy. In future research, classification can be carried out using other methods to get better accuracy results.

However, it is crucial to acknowledge the limitations of this research. One limitation is the potential lack of generalizability of the specific set of input shapes to diverse datasets and populations. Additionally, the study solely focuses on gender classification using ECG signals, disregarding other influencing factors. To address

these limitations, future research can explore alternative input shapes and architectures, incorporate larger and more diverse datasets, and develop new architectures by modifying the LSTM and Bi-LSTM architectures used. In addition, further research will be carried out by utilizing the transformation of the ECG signal. These efforts will help to improve the accuracy and robustness of gender classification models based on ECG signals.

#### Acknowledgement

This study results from a final project conducted in the Computer Science Department at the Faculty of Mathematics and Natural Sciences, Lambung Mangkurat University. The research was supported by the Program Dosen Wajib Meneliti (PDWM), funded by Lambung Mangkurat University.

#### REFERENCES

- [1] J. Rwigema, J. Mfitumukiza, and K. Tae-Yong, "A hybrid approach of neural networks for age and gender classification through decision fusion," *Biomed Signal Process Control*, vol. 66, p. 102459, 2021, <https://doi.org/10.1016/j.bspc.2021.102459>.
- [2] Y. Zhou, H. Ni, F. Ren, and X. Kang, "Face and gender recognition system based on convolutional neural networks," in *Proceedings of IEEE International Conference on Mechatronics and Automation, ICMA 2019*, pp. 1091–1095, 2019, <https://doi.org/10.1109/ICMA.2019.8816192>.
- [3] M. V. Rajee and C. Mythili, "Gender classification on digital dental x-ray images using deep convolutional neural network," *Biomed Signal Process Control*, vol. 69, 2021, <https://doi.org/10.1016/j.bspc.2021.102939>.
- [4] A. Krishnan, A. Almadan, and A. Rattani, "Understanding Fairness of Gender Classification Algorithms across Gender-Race Groups," *Proceedings - 19th IEEE International Conference on Machine Learning and Applications, ICMLA*, pp. 1028–1035, 2020, <https://doi.org/10.1109/ICMLA51294.2020.00167>.
- [5] A. Venugopal, Y. O. Yadukrishnan, and R. N. Nair, "A SVM based Gender Classification from Children Facial Images using Local Binary and Non-Binary Descriptors," in *Proceedings of the 4th International Conference on Computing Methodologies and Communication, ICCMC*, pp. 631–634, 2020, <https://doi.org/10.1109/ICCMC48092.2020.ICCMC-000117>.
- [6] J. Upadhyay and T. Gonsalves, "Robust and Lightweight System for Gait-Based Gender Classification toward Viewing Angle Variations," *AI*, vol. 3, no. 2, pp. 538–553, 2022, <https://doi.org/10.3390/ai3020031>.
- [7] H. Zhao and P. Wang, "A Short Review of Age and Gender Recognition Based on Speech," in *Proceedings - 5th IEEE International Conference on Big Data Security on Cloud, BigDataSecurity 2019, 5th IEEE International Conference on High Performance and Smart Computing, HPSC and 4th IEEE International Conference on Intelligent Data and Security*, pp. 183–185, 2019, <https://doi.org/10.1109/BigDataSecurity-HPSC-IDS.2019.00042>.
- [8] S. Kumar, S. Singh, and J. Kumar, "Gender classification using machine learning with multi-feature method," in *IEEE 9th Annual Computing and Communication Workshop and Conference, CCWC*, pp. 648–653, 2019, <https://doi.org/10.1109/CCWC.2019.8666601>.
- [9] P. Vashisth and K. Meehan, "Gender Classification using Twitter Text Data," in *31st Irish Signals and Systems Conference, ISSC*, pp. 1–6, 2020, <https://doi.org/10.1109/ISSC49989.2020.9180161>.
- [10] J. E. Tapia and C. A. Perez, "Gender Classification from NIR Images by Using Quadrature Encoding Filters of the Most Relevant Features," *IEEE Access*, vol. 7, pp. 29114–29127, 2019, <https://doi.org/10.1109/ACCESS.2019.2902470>.
- [11] Z. Ahmad, A. Tabassum, L. Guan, and N. M. Khan, "ECG Heartbeat Classification Using Multimodal Fusion," *IEEE Access*, vol. 9, pp. 100615–100626, 2021, <https://doi.org/10.1109/ACCESS.2021.3097614>.
- [12] T. V. Janahiraman and P. Subramaniam, "Gender Classification Based on Asian Faces using Deep Learning," in *2019 IEEE 9th International Conference on System Engineering and Technology (ICSET)*, pp. 84–89, 2019, <https://doi.org/10.1109/ICSEngT.2019.8906399>.
- [13] C.-Y. Chen *et al.*, "Automated ECG classification based on 1D deep learning network," *Methods*, vol. 202, pp. 127–135, 2022, <https://doi.org/10.1016/j.ymeth.2021.04.021>.
- [14] S. R. Bajare and V. V. Ingale, "ECG Based Biometric for Human Identification using Convolutional Neural Network," in *2019 10th International Conference on Computing, Communication and Networking Technologies, ICCCNT 2019*, pp. 1–7, 2019, <https://doi.org/10.1109/ICCCNT45670.2019.8944895>.
- [15] N. Feng, S. Xu, Y. Liang, and K. Liu, "A Probabilistic Process Neural Network and Its Application in ECG Classification," *IEEE Access*, vol. 7, pp. 50431–50439, 2019, <https://doi.org/10.1109/ACCESS.2019.2910880>.
- [16] B. Fatimah, G. Priyanka, R. Sultana, and N. Rekha, "Analysis of ECG for biometric identification," in *2020 11th International Conference on Computing, Communication and Networking Technologies, ICCCNT*, pp. 1–5, 2020, <https://doi.org/10.1109/ICCCNT49239.2020.9225361>.
- [17] M. U. Khan, S. Aziz, K. Iqtidar, A. Saud, and Z. Azhar, "Biometric Authentication System Based on Electrocardiogram (ECG)," in *2019 13th International Conference on Mathematics, Actuarial Science, Computer Science and Statistics (MACS)*, pp. 1–6, 2019, <https://doi.org/10.1109/MACS48846.2019.9024820>.
- [18] F. Murat, O. Yildirim, M. Talo, U. B. Baloglu, Y. Demir, and U. R. Acharya, "Application of deep learning techniques for heartbeats detection using ECG signals-analysis and review.," *Comput Biol Med*, vol. 120, p. 103726, 2020, <https://doi.org/10.1016/j.compbimed.2020.103726>.

- [19] S. I. I. Safie, "ECG slope features for Biometric Authentication," in *2018 IEEE 5th International Conference on Smart Instrumentation, Measurement and Application (ICSIMA)*, pp. 1–5, 2018, <https://doi.org/10.1109/ICSIMA.2018.8688793>.
- [20] A. Goshvarpour and A. Goshvarpour, "Gender and age classification using a new Poincare section-based feature set of ECG," *Signal Image Video Process*, vol. 13, no. 3, pp. 531–539, 2019, <https://doi.org/10.1007/s11760-018-1379-5>.
- [21] D. Alduwaile and M. S. Islam, "Single Heartbeat ECG Biometric Recognition using Convolutional Neural Network," in *3rd International Conference on Advanced Science and Engineering, ICOASE*, pp. 145–150, 2020, <https://doi.org/10.1109/ICOASE51841.2020.9436592>.
- [22] E. H. A. Rady and A. S. Anwar, "Prediction of kidney disease stages using data mining algorithms," *Informatics in Medicine Unlocked*, vol. 15, 2019, <https://doi.org/10.1016/j.imu.2019.100178>.
- [23] S. Baloch and M. S. Muhammad, "An Intelligent Data Mining-Based Fault Detection and Classification Strategy for Microgrid," *IEEE Access*, vol. 9, pp. 22470–22479, 2021, <https://doi.org/10.1109/ACCESS.2021.3056534>.
- [24] S. Mohanty, L. Lydia, M. Elhoseny, M. Otaibi, and K. Shankar, "Deep learning with LSTM based distributed data mining model for energy efficient wireless sensor networks," *Physical Communication*, vol. 40, p. 101097, 2020, <https://doi.org/10.1016/j.phycom.2020.101097>.
- [25] L. Jiang, X. Sun, F. Mercaldo, and A. Santone, "DECAB-LSTM: Deep Contextualized Attentional Bidirectional LSTM for cancer hallmark classification," *Knowl Based Syst*, vol. 210, p. 106486, 2020, <https://doi.org/10.1016/j.knsys.2020.106486>.
- [26] Y. Sari, Y. Firmanul Arifin, N. Novitasari, and M. R. Faisal, "Deep Learning Approach Using the GRU-LSTM Hybrid Model for Air Temperature Prediction on Daily Basis," *International Journal of Intelligent Systems and Applications in Engineering*, vol. 10, no. 3, pp. 430–436, 2022, <https://www.ijisae.org/index.php/IJISAE/article/view/2184>.
- [27] C. Hu *et al.*, "LSTM-RNN-based defect classification in honeycomb structures using infrared thermography," *Infrared Phys Technol*, vol. 102, p. 103032, 2019, <https://doi.org/10.1016/j.infrared.2019.103032>.
- [28] S. Belagoune, N. Bali, A. Bakdi, B. Baadji, and K. Atif, "Deep learning through LSTM classification and regression for transmission line fault detection, diagnosis and location in large-scale multi-machine power systems," *Measurement (Lond)*, vol. 177, 2021, <https://doi.org/10.1016/j.measurement.2021.109330>.
- [29] X. Zheng and W. Chen, "An Attention-based Bi-LSTM Method for Visual Object Classification via EEG," *Biomed Signal Process Control*, vol. 63, 2021, <https://doi.org/10.1016/j.bspc.2020.102174>.
- [30] Z. Hameed, B. Garcia-Zapirain, and I. O. Ruiz, "A computationally efficient BiLSTM based approach for the binary sentiment classification," in *2019 IEEE 19th International Symposium on Signal Processing and Information Technology, ISSPIT*, pp. 1–4, 2019, <https://doi.org/10.1109/ISSPIT47144.2019.9001781>.
- [31] A. Rana and K. K. Kim, "ECG Heartbeat Classification Using a Single Layer LSTM Model," in *Proceedings - 2019 International SoC Design Conference, ISOC*, pp. 267–268, 2019, <https://doi.org/10.1109/ISOC47750.2019.9027740>.
- [32] R. Anhar, T. B. Adji, and N. Akhmad Setiawan, "Question classification on question-answer system using bidirectional-LSTM," in *Proceedings - 2019 5th International Conference on Science and Technology, ICST*, vol. 1, pp. 1–5, 2019, <https://doi.org/10.1109/ICST47872.2019.9166190>.
- [33] D. Krishnani, A. Kumari, A. Dewangan, A. Singh, and N. S. Naik, "Prediction of Coronary Heart Disease using Supervised Machine Learning Algorithms," in *TENCON IEEE Region 10 Conference (TENCON)*, pp. 367–372, 2019, <https://doi.org/10.1109/TENCON.2019.8929434>.
- [34] M. K. Delimayanti, R. Sari, M. Laya, M. R. Faisal, Pahrul, and R. F. Naryanto, "The effect of pre-processing on the classification of twitter's flood disaster messages using support vector machine algorithm," in *Proceedings of ICAE 2020 - 3rd International Conference on Applied Engineering*, pp. 1–6, 2020, <https://doi.org/10.1109/ICAE50557.2020.9350387>.
- [35] V. N. G. Raju, K. P. Lakshmi, V. M. Jain, A. Kalidindi, and V. Padma, "Study the Influence of Normalization/Transformation process on the Accuracy of Supervised Classification," in *Proceedings of the 3rd International Conference on Smart Systems and Inventive Technology, ICSSIT*, pp. 729–735, 2020, <https://doi.org/10.1109/ICSSIT48917.2020.9214160>.
- [36] C. Chen, Z. Hua, R. Zhang, G. Liu, and W. Wen, "Automated arrhythmia classification based on a combination network of CNN and LSTM," *Biomed Signal Process Control*, vol. 57, 2020, <https://doi.org/10.1016/j.bspc.2019.101819>.
- [37] P. Singh and P. Sehgal, "G.V Black dental caries classification and preparation technique using optimal CNN-LSTM classifier," *Multimed Tools Appl*, vol. 80, no. 4, pp. 5255–5272, 2021, <https://doi.org/10.1007/s11042-020-09891-6>.
- [38] Y. Lu, J. Zhou, H. N. Dai, H. Wangt, and H. Xiao, "Sentiment analysis of Chinese microblog based on stacked bidirectional LSTM," in *Proceedings - 2018 15th International Symposium on Pervasive Systems, Algorithms and Networks, I-SPAN*, pp. 162–167, 2019, <https://doi.org/10.1109/I-SPAN.2018.00034>.
- [39] K. Y. Firlia, M. R. Faisal, D. Kartini, R. A. Nugroho, and F. Abadi, "Analysis of New Features on the Performance of the Support Vector Machine Algorithm in Classification of Natural Disaster Messages," in *Proceedings - 2021 4th International Conference on Computer and Informatics Engineering: IT-Based Digital Industrial Innovation for the Welfare of Society, IC2IE*, pp. 317–322, 2021, <https://doi.org/10.1109/IC2IE53219.2021.9649107>.
- [40] M. I. Saputra, I. Budiman, D. Kartini, D. T. Nugrahadi, and M. R. Faisal, "Performance Comparison of Adaptive Neuro Fuzzy Inference System and Support Vector Machine Algorithm in Balanced and Unbalanced Multiclass Data

Classification,” in *Proceedings - 2021 4th International Conference on Computer and Informatics Engineering: IT-Based Digital Industrial Innovation for the Welfare of Society, IC2IE*, pp. 36–39, 2021, <https://doi.org/10.1109/IC2IE53219.2021.9649423>.

- [41] Alghifari, D. R., Edi, M., & Firmansyah, L. . Implementasi Bidirectional LSTM untuk Analisis Sentimen Terhadap Layanan Grab Indonesia. *Jurnal Manajemen Informatika (JAMIKA)*, vol. 12, no. 2, pp. 89-99, 2022, <https://doi.org/10.34010/jamika.v12i2.7764>.

## BIOGRAPHY OF AUTHORS



**Kevin Yudhaprawira Halim** is an undergraduate student in the Department of Computer Science, Lambung Mangkurat University. Her research interest is centered on Data Mining. Email: [1911016210003@mhs.ulm.ac.id](mailto:1911016210003@mhs.ulm.ac.id)



**Dodon Turianto Nugrahadi** adalah is a lecturer in Department of Computer Science, Lambung Mangkurat University. His research interest is centered on Data Science. Email: [dodonturianto@ulm.ac.id](mailto:dodonturianto@ulm.ac.id)



**Mohammad Reza Faisal** is a lecturer in Department of Computer Science, Lambung Mangkurat University. His research interest is centered on Data Science. Email: [reza.faisal@ulm.ac.id](mailto:reza.faisal@ulm.ac.id)



**Rudy Herteno** is a lecturer in Department of Computer Science, Lambung Mangkurat University. His research interest is centered on Data Science. Email: [rudy.herteno@ulm.ac.id](mailto:rudy.herteno@ulm.ac.id)



**Irwan Budiman** is a lecturer in Department of Computer Science, Lambung Mangkurat University. His research interest is centered on Data Science. Email: [irwan.budiman@ulm.ac.id](mailto:irwan.budiman@ulm.ac.id)